

JAIN SPIN CLEAN FILTERS - 20MM & 25MM

AG Products Spin Clean® filters are unique in that incoming dirty water is forced through a directional nozzle plate onto the inside of the stainless steel screen. This creates a centrifugal action which rotates debris down the screen wall to the large debris holding basin. Debris is flushed out via a ball valve or unscrewing cap. A spinning action keeps more of the screen area clean, minimizing pressure losses due to excessive dirt build-up.

Features

- 20mm and 25mm inlet/outlet
- Two piece threaded housing with O ring seal for easy maintenance
- Moulded from high heat and chemical resistant ABS Plastic
- Ball Valve for flushing debris
- Strong, stainless steel filter screens available in mesh sizes of 50, 100 and 150 (please specify when ordering)
- Removable flushing cap



Applications

- High quality screen filter for agriculture and landscape irrigation systems

Specifications

Max Recommended Operating Pressure:	550kPa
20mm Maximum Flow Rate:	42lpm
25mm Maximum Flow Rate:	105lpm
20mm Maximum size cleaning efficiency:	15lpm
25mm Maximum size cleaning efficiency:	26lpm
20mm Screen area:	585mm
25mm Screen area:	710mm

Part No.	Description
20mm Spin Clean Filters - with Flushing outlet valve	
4E20-50	20mm x 50 mesh screen
4E20-100	20mm x 100 mesh screen
4E20-150	20mm x 150 mesh screen
20mm Spin Clean Filters - Spare Parts	
20SC-50	Screen Only 50 mesh (Yellow)
20SC-100	Screen Only 100 mesh (Blue)
20SC-150	Screen Only 150 mesh (Black)
4E20-B	20mm Spin Clean Filter Body Only
4E20-ORING	20/25mm Spin Clean Filter - Body ORing
4E20-SP	20/25mm Spin Clean Filter - Spin Plate
FOV	Flushing Outlet Valve

Part No.	Description
25mm Spin Clean Filters - with Flushing outlet valve	
4E25-50	25mm x 50 mesh screen
4E25-100	25mm x 100 mesh screen
4E25-150	25mm x 150 mesh screen
25mm Spin Clean Filters - Spare Parts	
25SC-50	Screen Only 50 mesh (Yellow)
25SC-100	Screen Only 100 mesh (Blue)
25SC-150	Screen Only 150 mesh (Black)
4E25-B	25mm Spin Clean Filter Body Only
4E20-ORING	20/25mm Spin Clean Filter - Body ORing
4E20-SP	20/25mm Spin Clean Filter - Spin Plate
FOV	Flushing Outlet Valve



JAIN SPIN CLEAN FILTERS - 20MM & 25MM

FLOW CHARACTERISTICS

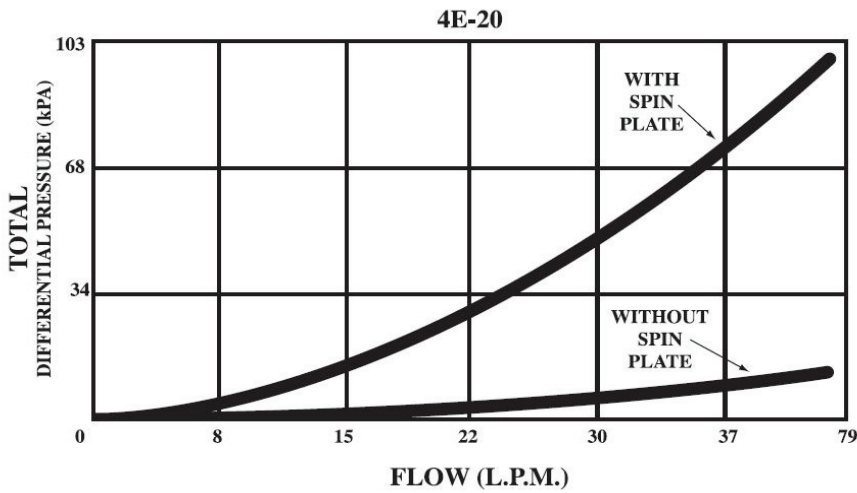

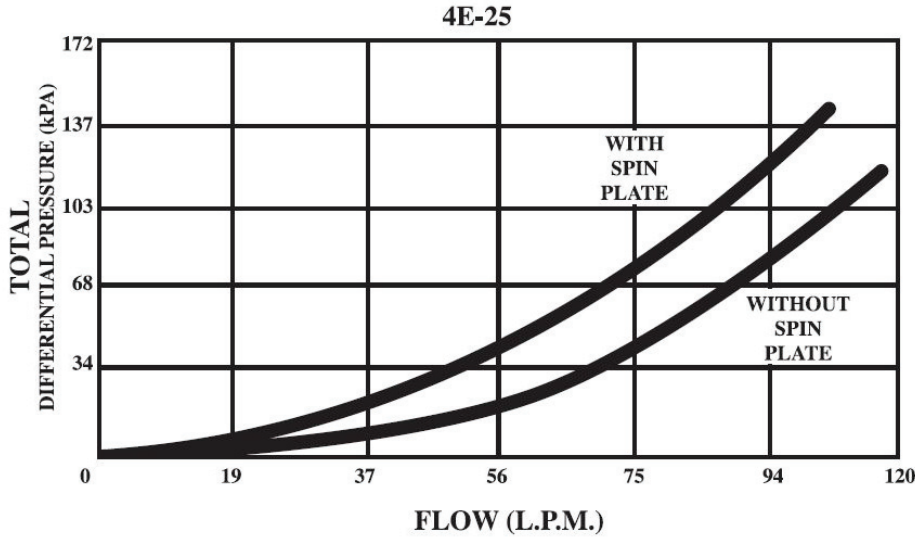

20mm Filter



25mm Filter



FILTER SCREEN MESH/ MICRON CONVERSIONS

Filter Screen Mesh / Micron Conversions			
Mesh	50	100	150
Inch	.012	.006	.004
Micron	300	152	100
Colour	Yellow	Blue	Black
			

JAIN SPIN CLEAN FILTERS - 20MM & 25MM

FILTER DIMENSIONS

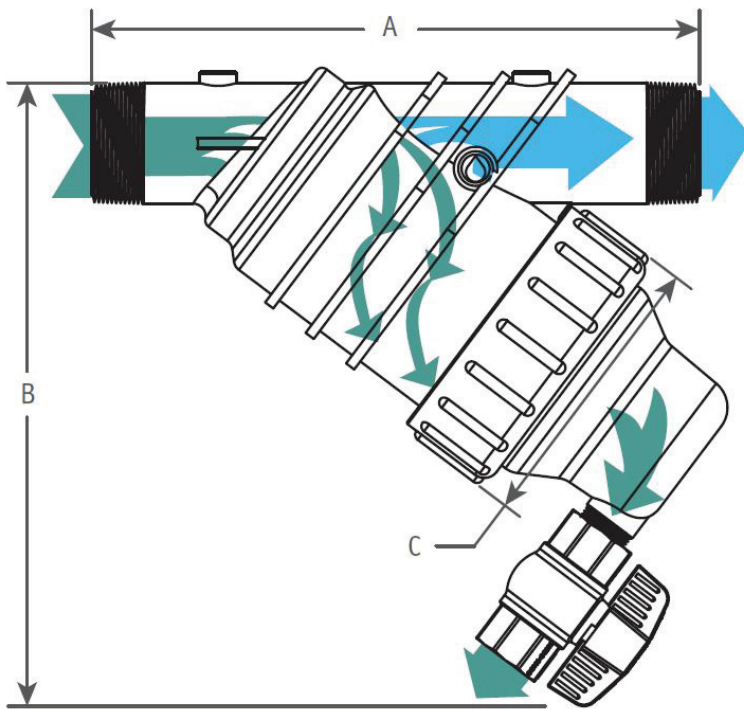

Physical Dimensions			
	A	B	C
Size	cm	cm	cm
20mm	15.8	21.6	7.6
25mm	17.3	24.1	7.6

MINIMUM CLEARANCE

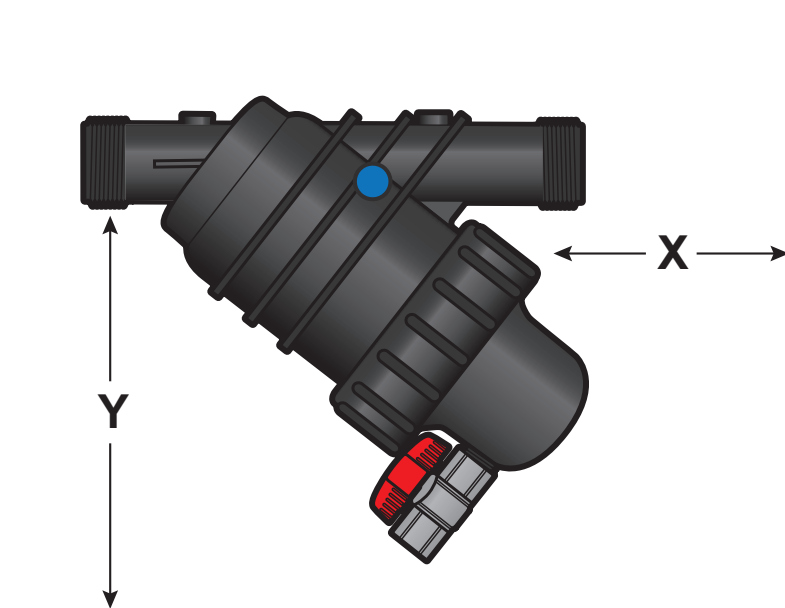

Size	X	Y
4E - 20mm & 25mm with valve	150mm	200mm